



## TELUX™

### Description

The TELUX™ series is a clear, non diffused LED for applications where supreme luminous flux is required. It is designed in an industry standard 7.62 mm square package utilizing highly developed (AS) AlInGaP technology.

The supreme heat dissipation of TELUX™ allows applications at high ambient temperatures.

All packing units are binned for luminous flux, forward voltage and color to achieve the most homogenous light appearance in application.

SAE and ECE color requirements for automobile application are available for color red.

ESD resistivity 2kV (HBM) according to MIL STD 883D, method 3015.7.

### Features

- Utilizing one of the world's brightest (AS) AlInGaP technologies
- High luminous flux
- Supreme heat dissipation:  $R_{thJP}$  is 90 K/W
- High operating temperature:  
 $T_{amb} = -40$  to  $+110$  °C
- Meets SAE and ECE color requirements for the automobile industry for color red
- Packed in tubes for automatic insertion
- Luminous flux, forward voltage and color categorized for each tube
- Small mechanical tolerances allow precise usage of external reflectors or lightguides

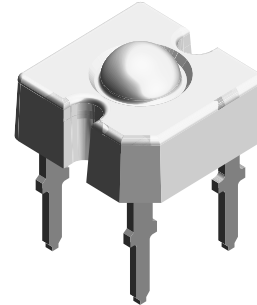

16 012

### Applications

- Exterior lighting
- Dashboard illumination
- Tail-, Stop - and Turn Signals of motor vehicles
- Replaces small incandescent lamps
- Traffic signals and signs

### Parts Table

Part	Color, Luminous Intensity	Angle of Half Intensity ( $\pm\phi$ )	Technology
TLWR8900	Red, $\phi_V = 3000$ mlm (typ.)	45 °	AlInGaP on GaAs
TLWY8900	Yellow, $\phi_V = 3000$ mlm (typ.)	45 °	AlInGaP on GaAs
TLWTG8900	True green, $\phi_V = 3000$ mlm (typ.)	45 °	InGaN on SiC
TLWBG8900	Blue green, $\phi_V = 1300$ mlm (typ.)	45 °	InGaN on SiC
TLWB8900	Blue, $\phi_V = 650$ mlm (typ.)	45 °	InGaN on SiC

### Absolute Maximum Ratings

$T_{amb} = 25\text{ }^{\circ}\text{C}$ , unless otherwise specified

TLWR8900, TLWY8900,

Parameter	Test condition	Symbol	Value	Unit
Reverse voltage	$I_R = 100\text{ }\mu\text{A}$	$V_R$	10	V
DC Forward current	$T_{amb} \leq 85\text{ }^{\circ}\text{C}$	$I_F$	70	mA
Surge forward current	$t_p \leq 10\text{ }\mu\text{s}$	$I_{FSM}$	1	A
Power dissipation	$T_{amb} \leq 85\text{ }^{\circ}\text{C}$	$P_V$	187	mW
Junction temperature		$T_j$	125	$^{\circ}\text{C}$
Operating temperature range		$T_{amb}$	- 40 to + 110	$^{\circ}\text{C}$
Storage temperature range		$T_{stg}$	- 55 to + 110	$^{\circ}\text{C}$
Soldering temperature	$t \leq 5\text{ s}$ , 1.5 mm from body preheat temperature 100 $^{\circ}\text{C}$ / 30 sec.	$T_{sd}$	260	$^{\circ}\text{C}$
Thermal resistance junction/ ambient	with cathode heatsink of 70 $\text{mm}^2$	$R_{thJA}$	200	K/W

TLWTG8900, TLWBG8900, TLWB8900

Parameter	Test condition	Symbol	Value	Unit
Reverse voltage	$I_R = 10\text{ }\mu\text{A}$	$V_R$	5	V
DC Forward current	$T_{amb} \leq 50\text{ }^{\circ}\text{C}$	$I_F$	50	mA
Surge forward current	$t_p \leq 10\text{ }\mu\text{s}$	$I_{FSM}$	0.1	A
Power dissipation	$T_{amb} \leq 50\text{ }^{\circ}\text{C}$	$P_V$	230	mW
Junction temperature		$T_j$	100	$^{\circ}\text{C}$
Operating temperature range		$T_{amb}$	- 40 to + 100	$^{\circ}\text{C}$
Storage temperature range		$T_{stg}$	- 55 to + 100	$^{\circ}\text{C}$
Soldering temperature	$t \leq 5\text{ s}$ , 1.5 mm from body preheat temperature 100 $^{\circ}\text{C}$ / 30 sec.	$T_{sd}$	260	$^{\circ}\text{C}$
Thermal resistance junction/ ambient	with cathode heatsink of 70 $\text{mm}^2$	$R_{thJA}$	200	K/W
Thermal resistance junction/pin		$R_{thJP}$	90	K/W

### Optical and Electrical Characteristics

$T_{amb} = 25\text{ }^{\circ}\text{C}$ , unless otherwise specified

#### Red

TLWR8900

Parameter	Test condition	Symbol	Min	Typ.	Max	Unit
Total flux	$I_F = 70\text{ mA}$ , $R_{thJA} = 200\text{ }^{\circ}\text{K/W}$	$\phi_V$	2000	3000		mlm
Luminous intensity/Total flux	$I_F = 70\text{ mA}$ , $R_{thJA} = 200\text{ }^{\circ}\text{K/W}$	$I_V/\phi_V$		0.7		mcd/mlm
Dominant wavelength	$I_F = 70\text{ mA}$ , $R_{thJA} = 200\text{ }^{\circ}\text{K/W}$	$\lambda_d$	611	615	634	nm
Peak wavelength	$I_F = 70\text{ mA}$ , $R_{thJA} = 200\text{ }^{\circ}\text{K/W}$	$\lambda_p$		624		nm
Angle of half intensity	$I_F = 70\text{ mA}$ , $R_{thJA} = 200\text{ }^{\circ}\text{K/W}$	$\phi$		$\pm 45$		deg
Total included angle	90 % of Total Flux Captured	$\phi_{0.9V}$		75		deg
Forward voltage	$I_F = 70\text{ mA}$ , $R_{thJA} = 200\text{ }^{\circ}\text{K/W}$	$V_F$	2.0	2.2	2.7	V
Reverse voltage	$I_R = 10\text{ }\mu\text{A}$	$V_R$	10	20		V
Junction capacitance	$V_R = 0$ , $f = 1\text{ MHz}$	$C_j$		17		pF



### Yellow

#### TLWY8900

Parameter	Test condition	Symbol	Min	Typ.	Max	Unit
Total flux	$I_F = 70 \text{ mA}$ , $R_{thJA} = 200 \text{ }^\circ\text{K/W}$	$\phi_V$	2000	3000		mlm
Luminous intensity/Total flux	$I_F = 70 \text{ mA}$ , $R_{thJA} = 200 \text{ }^\circ\text{K/W}$	$I_V/\phi_V$		0.7		mcd/mlm
Dominant wavelength	$I_F = 70 \text{ mA}$ , $R_{thJA} = 200 \text{ }^\circ\text{K/W}$	$\lambda_d$	585	590	597	nm
Peak wavelength	$I_F = 70 \text{ mA}$ , $R_{thJA} = 200 \text{ }^\circ\text{K/W}$	$\lambda_p$		594		nm
Angle of half intensity	$I_F = 70 \text{ mA}$ , $R_{thJA} = 200 \text{ }^\circ\text{K/W}$	$\phi$		$\pm 45$		deg
Total included angle	90 % of Total Flux Captured	$\phi_{0.9V}$		75		deg
Forward voltage	$I_F = 70 \text{ mA}$ , $R_{thJA} = 200 \text{ }^\circ\text{K/W}$	$V_F$	1.83	2.1	2.7	V
Reverse voltage	$I_R = 10 \text{ } \mu\text{A}$	$V_R$	10	15		V
Junction capacitance	$V_R = 0$ , $f = 1 \text{ MHz}$	$C_j$		17		pF

### True green

#### TLWTG8900

Parameter	Test condition	Symbol	Min	Typ.	Max	Unit
Total flux	$I_F = 50 \text{ mA}$ , $R_{thJA} = 200 \text{ }^\circ\text{K/W}$	$\phi_V$	1000	2000		mlm
Luminous intensity/Total flux	$I_F = 50 \text{ mA}$ , $R_{thJA} = 200 \text{ }^\circ\text{K/W}$	$I_V/\phi_V$		0.7		mcd/mlm
Dominant wavelength	$I_F = 50 \text{ mA}$ , $R_{thJA} = 200 \text{ }^\circ\text{K/W}$	$\lambda_d$	509	523	529	nm
Peak wavelength	$I_F = 50 \text{ mA}$ , $R_{thJA} = 200 \text{ }^\circ\text{K/W}$	$\lambda_p$		518		nm
Angle of half intensity	$I_F = 50 \text{ mA}$ , $R_{thJA} = 200 \text{ }^\circ\text{K/W}$	$\phi$		$\pm 45$		deg
Total included angle	90 % of Total Flux Captured	$\phi$		100		deg
Forward voltage	$I_F = 50 \text{ mA}$ , $R_{thJA} = 200 \text{ }^\circ\text{K/W}$	$V_F$		4.4	5.0	V
Reverse voltage	$I_R = 10 \text{ } \mu\text{A}$	$V_R$	5	10		V
Junction capacitance	$V_R = 0$ , $f = 1 \text{ MHz}$	$C_j$		50		pF
Temperature coefficient of $\lambda_{dom}$	$I_F = 30 \text{ mA}$	$TC_{\lambda_{dom}}$		0.02		nm/K

### Blue green

#### TLWBG8900

Parameter	Test condition	Symbol	Min	Typ.	Max	Unit
Total flux	$I_F = 50 \text{ mA}$ , $R_{thJA} = 200 \text{ }^\circ\text{K/W}$	$\phi_V$	630	1300		mlm
Luminous intensity/Total flux	$I_F = 50 \text{ mA}$ , $R_{thJA} = 200 \text{ }^\circ\text{K/W}$	$I_V/\phi_V$		0.7		mcd/mlm
Dominant wavelength	$I_F = 50 \text{ mA}$ , $R_{thJA} = 200 \text{ }^\circ\text{K/W}$	$\lambda_d$	492	505	510	nm
Peak wavelength	$I_F = 50 \text{ mA}$ , $R_{thJA} = 200 \text{ }^\circ\text{K/W}$	$\lambda_p$		503		nm
Angle of half intensity	$I_F = 50 \text{ mA}$ , $R_{thJA} = 200 \text{ }^\circ\text{K/W}$	$\phi$		$\pm 45$		deg
Total included angle	90 % of Total Flux Captured	$\phi$		100		deg
Forward voltage	$I_F = 50 \text{ mA}$ , $R_{thJA} = 200 \text{ }^\circ\text{K/W}$	$V_F$		4.4	5.0	V
Reverse voltage	$I_R = 10 \text{ } \mu\text{A}$	$V_R$	5	10		V
Junction capacitance	$V_R = 0$ , $f = 1 \text{ MHz}$	$C_j$		50		pF
Temperature coefficient of $\lambda_{dom}$	$I_F = 30 \text{ mA}$	$TC_{\lambda_{dom}}$		0.02		nm/K

### Blue

#### TLWB8900

Parameter	Test condition	Symbol	Min	Typ.	Max	Unit
Total flux	$I_F = 50 \text{ mA}$ , $R_{thJA} = 200 \text{ }^\circ\text{K/W}$	$\phi_V$	320	650		mIm
Luminous intensity/Total flux	$I_F = 50 \text{ mA}$ , $R_{thJA} = 200 \text{ }^\circ\text{K/W}$	$I_V/\phi_V$		0.7		mcd/mIm
Dominant wavelength	$I_F = 50 \text{ mA}$ , $R_{thJA} = 200 \text{ }^\circ\text{K/W}$	$\lambda_d$	462	470	476	nm
Peak wavelength	$I_F = 50 \text{ mA}$ , $R_{thJA} = 200 \text{ }^\circ\text{K/W}$	$\lambda_p$		460		nm
Angle of half intensity	$I_F = 50 \text{ mA}$ , $R_{thJA} = 200 \text{ }^\circ\text{K/W}$	$\phi$		$\pm 45$		deg
Total included angle	90 % of Total Flux Captured	$\phi$		100		deg
Forward voltage	$I_F = 50 \text{ mA}$ , $R_{thJA} = 200 \text{ }^\circ\text{K/W}$	$V_F$		4.4	5.0	V
Reverse voltage	$I_R = 10 \text{ } \mu\text{A}$	$V_R$	5	10		V
Junction capacitance	$V_R = 0$ , $f = 1 \text{ MHz}$	$C_j$		50		pF
Temperature coefficient of $\lambda_{dom}$	$I_F = 30 \text{ mA}$	$TC_{\lambda_{dom}}$		0.03		nm/K

### Typical Characteristics ( $T_{amb} = 25 \text{ }^\circ\text{C}$ unless otherwise specified)

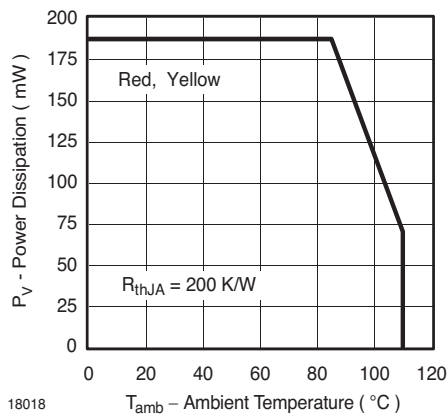

Figure 1. Power Dissipation vs. Ambient Temperature

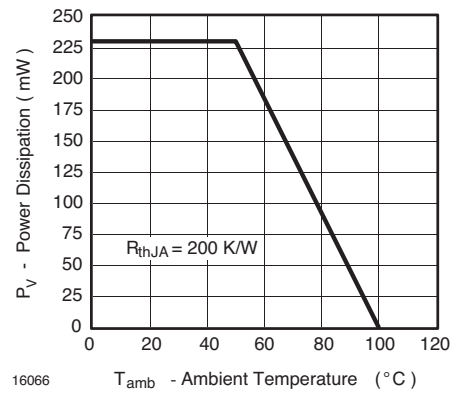

Figure 3. Power Dissipation vs. Ambient Temperature for InGaN

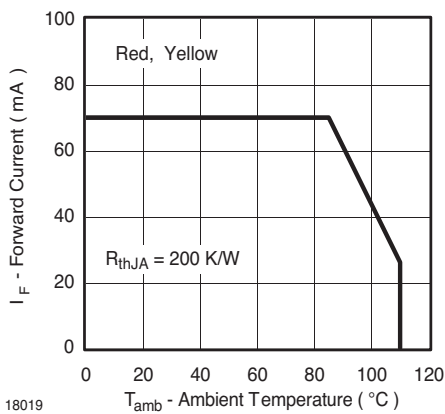

Figure 2. Forward Current vs. Ambient Temperature

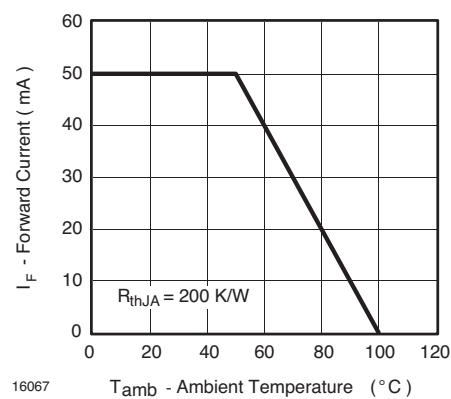

Figure 4. Forward Current vs. Ambient Temperature for InGaN

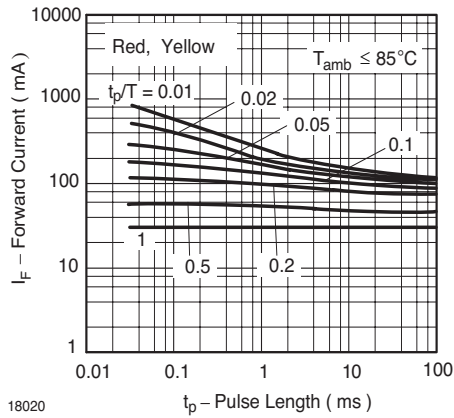

Figure 5. Forward Current vs. Pulse Length

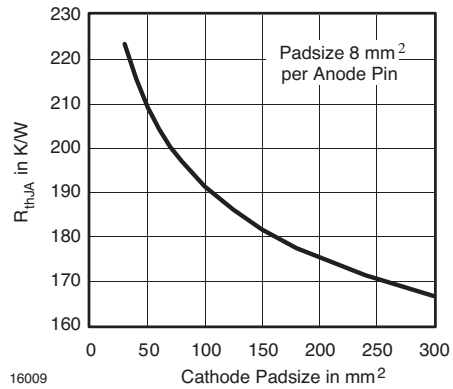

Figure 8. Thermal Resistance Junction Ambient vs. Cathode Padsize

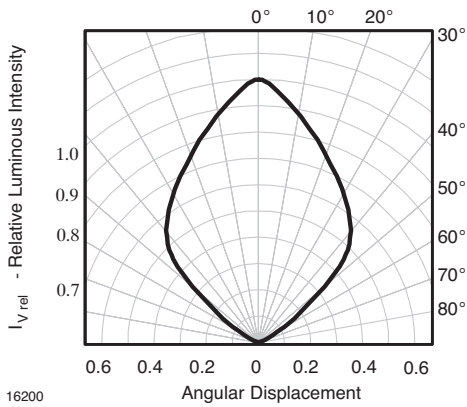

Figure 6. Rel. Luminous Intensity vs. Angular Displacement

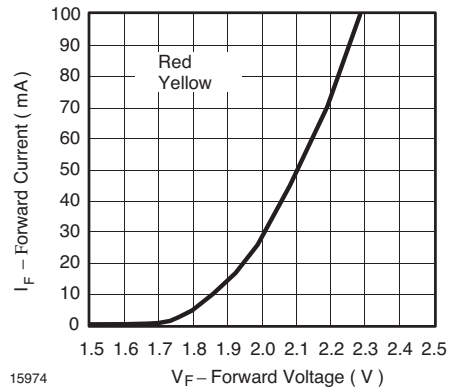

Figure 9. Forward Current vs. Forward Voltage

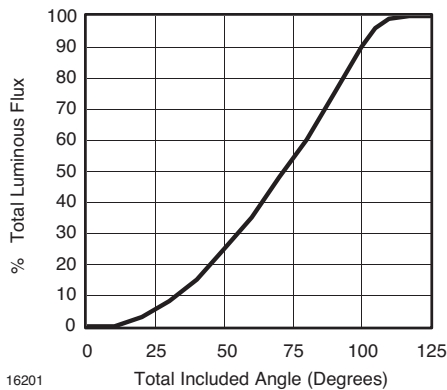

Figure 7. Percentage Total Luminous Flux vs. Total Included Angle for 90° emission angle

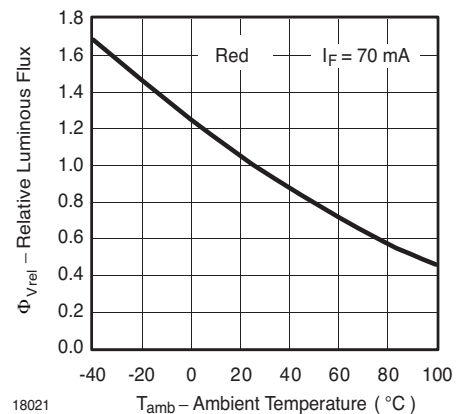

Figure 10. Rel. Luminous Flux vs. Ambient Temperature

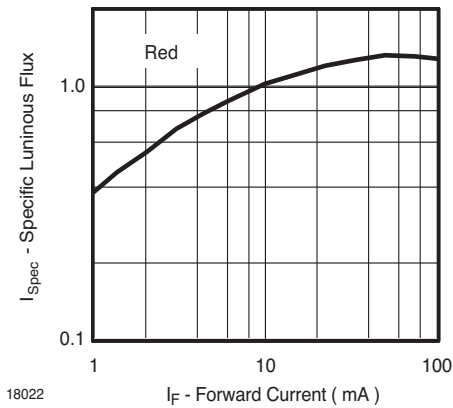

Figure 11. Specific Luminous Flux vs. Forward Current

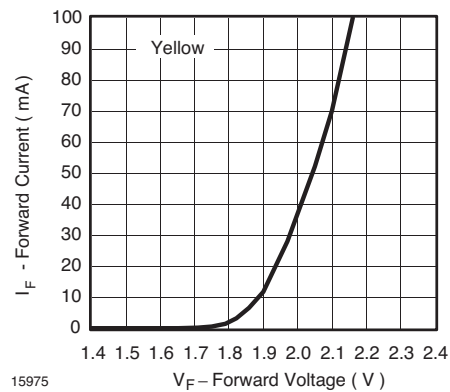

Figure 14. Forward Current vs. Forward Voltage

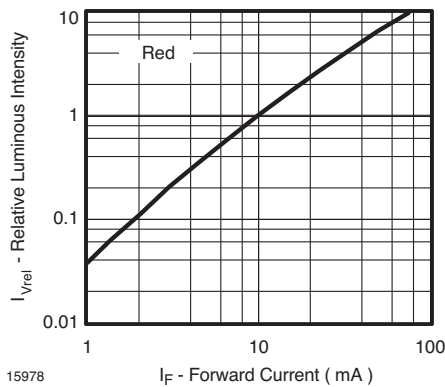

Figure 12. Relative Luminous Flux vs. Forward Current

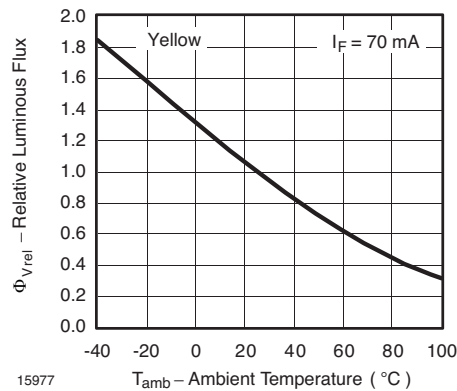

Figure 15. Rel. Luminous Flux vs. Ambient Temperature

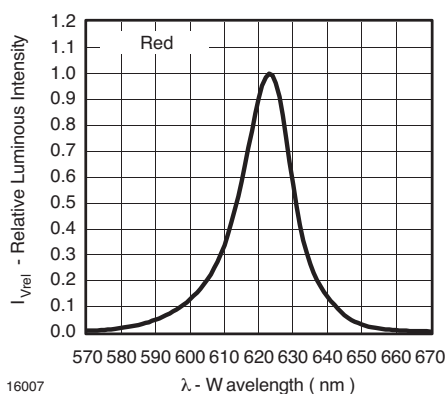

Figure 13. Relative Intensity vs. Wavelength

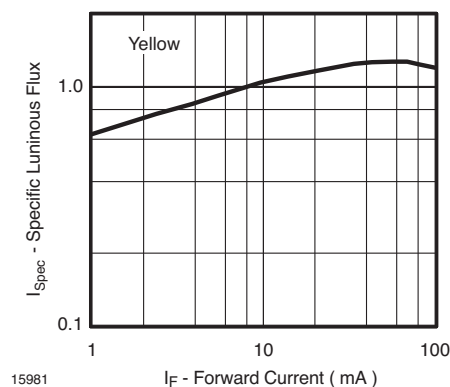

Figure 16. Specific Luminous Flux vs. Forward Current

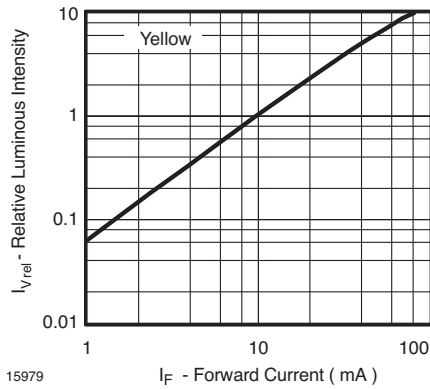

Figure 17. Relative Luminous Flux vs. Forward Current

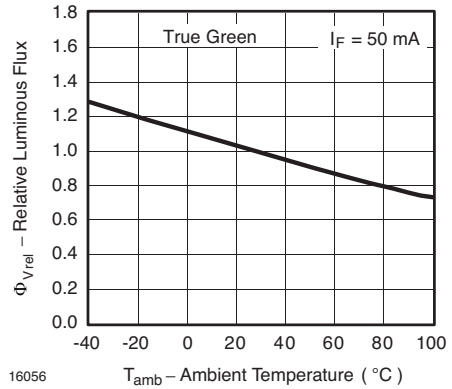

Figure 20. Rel. Luminous Flux vs. Ambient Temperature

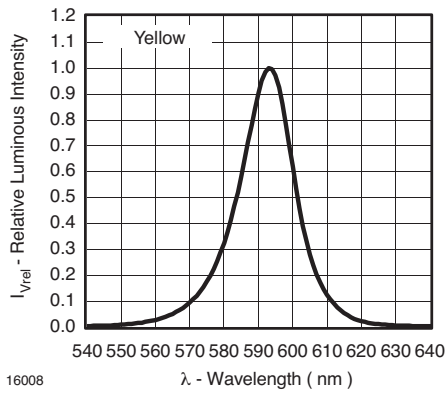

Figure 18. Relative Intensity vs. Wavelength

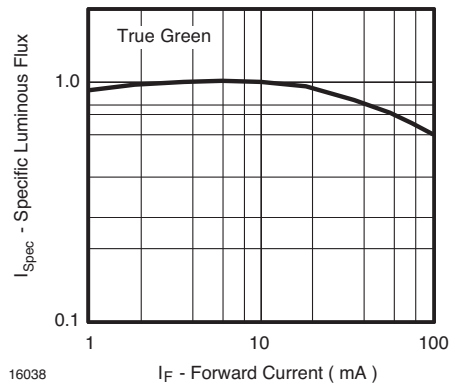

Figure 21. Specific Luminous Flux vs. Forward Current

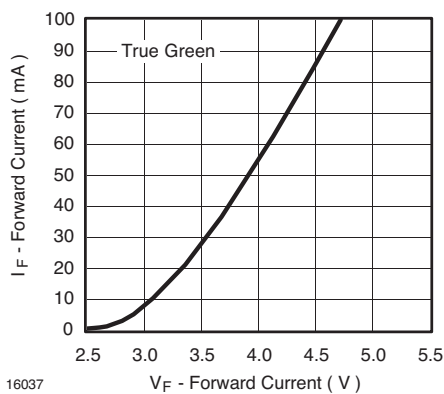

Figure 19. Forward Current vs. Forward Voltage

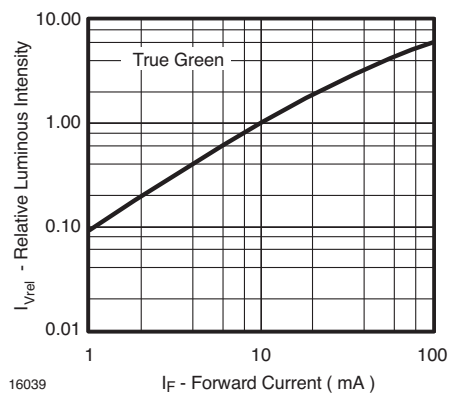

Figure 22. Relative Luminous Flux vs. Forward Current

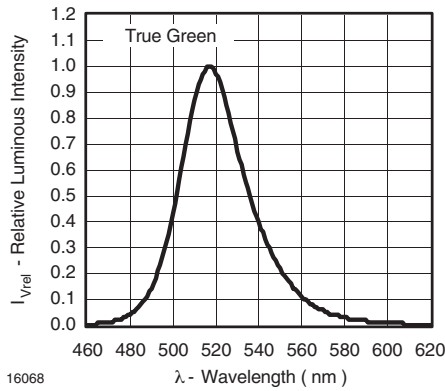

Figure 23. Relative Intensity vs. Wavelength

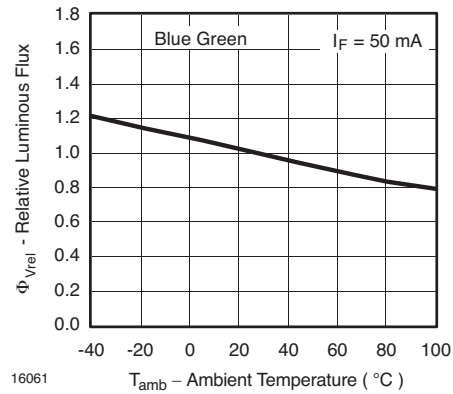

Figure 26. Rel. Luminous Flux vs. Ambient Temperature

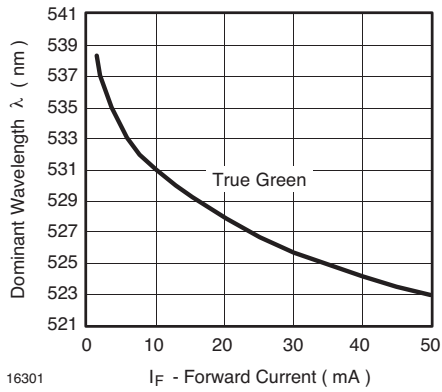

Figure 24. Dominant Wavelength vs. Forward Current

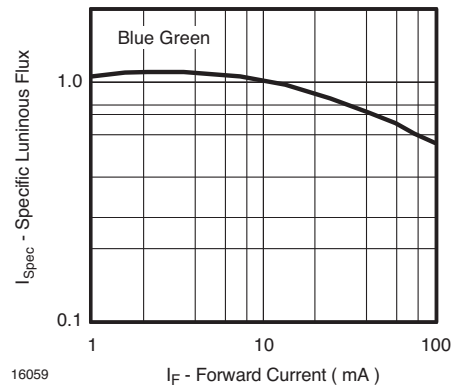

Figure 27. Specific Luminous Flux vs. Forward Current

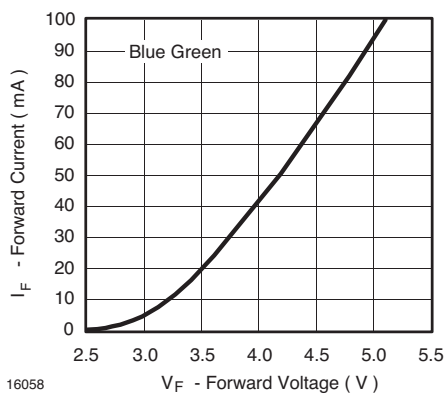

Figure 25. Forward Current vs. Forward Voltage

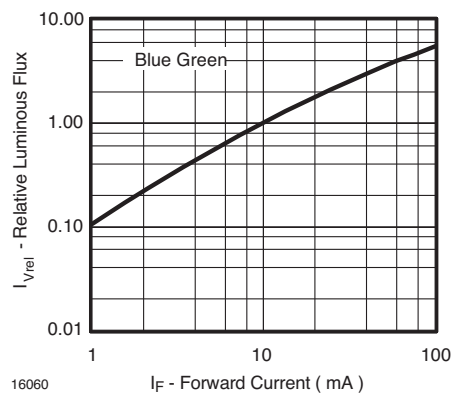

Figure 28. Relative Luminous Flux vs. Forward Current



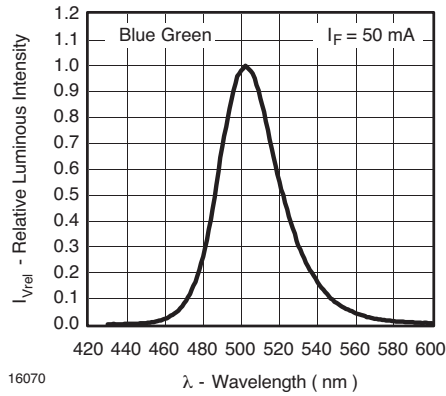

Figure 29. Relative Intensity vs. Wavelength

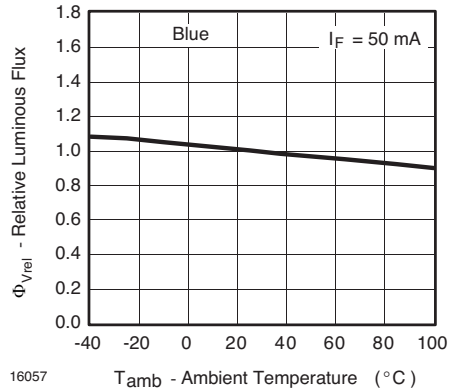

Figure 32. Rel. Luminous Flux vs. Ambient Temperature

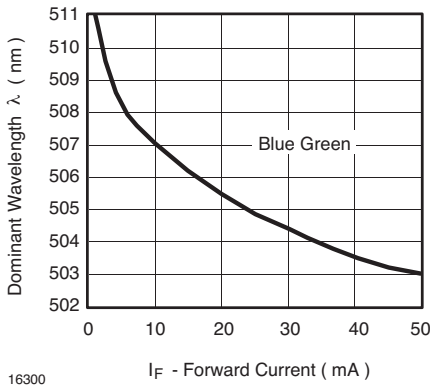

Figure 30. Dominant Wavelength vs. Forward Current

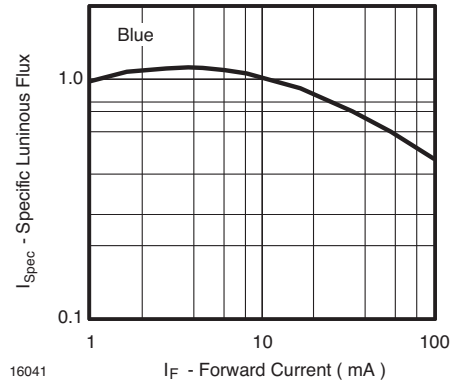

Figure 33. Specific Luminous Flux vs. Forward Current

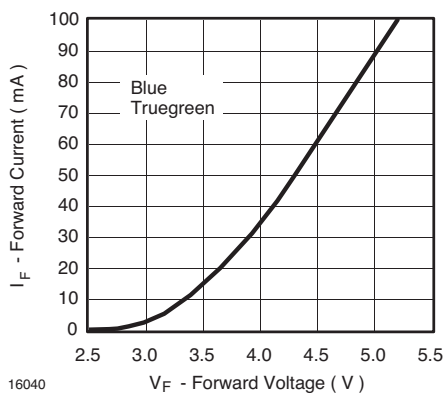

Figure 31. Forward Current vs. Forward Voltage

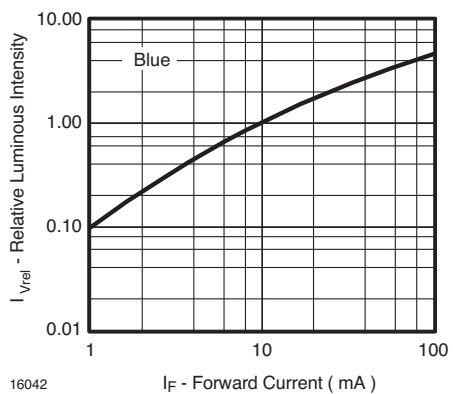

Figure 34. Relative Luminous Flux vs. Forward Current

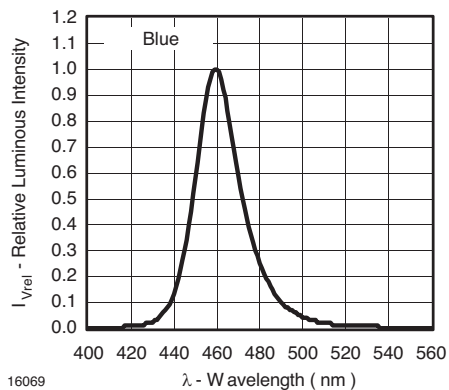

Figure 35. Relative Intensity vs. Wavelength

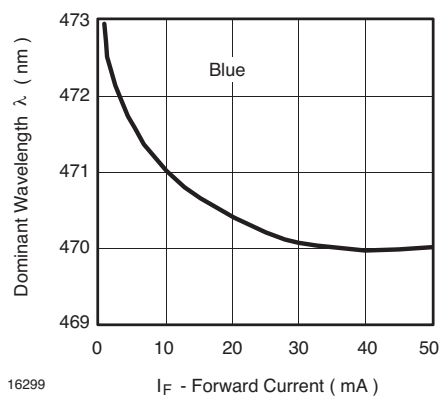
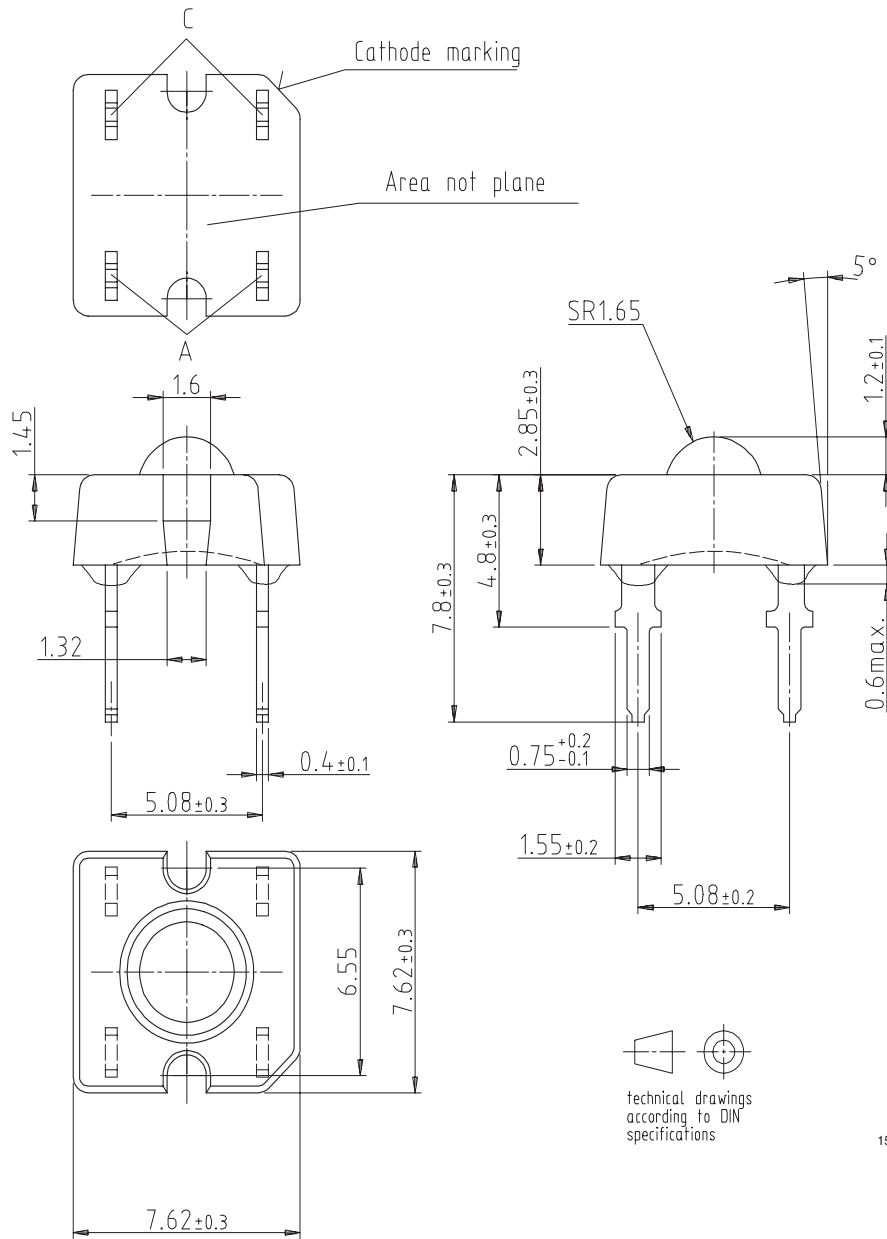

Figure 36. Dominant Wavelength vs. Forward Current

## Package Dimensions in mm



### Ozone Depleting Substances Policy Statement

It is the policy of **Vishay Semiconductor GmbH** to

1. Meet all present and future national and international statutory requirements.
2. Regularly and continuously improve the performance of our products, processes, distribution and operating systems with respect to their impact on the health and safety of our employees and the public, as well as their impact on the environment.

It is particular concern to control or eliminate releases of those substances into the atmosphere which are known as ozone depleting substances (ODSs).

The Montreal Protocol (1987) and its London Amendments (1990) intend to severely restrict the use of ODSs and forbid their use within the next ten years. Various national and international initiatives are pressing for an earlier ban on these substances.

**Vishay Semiconductor GmbH** has been able to use its policy of continuous improvements to eliminate the use of ODSs listed in the following documents.

1. Annex A, B and list of transitional substances of the Montreal Protocol and the London Amendments respectively
2. Class I and II ozone depleting substances in the Clean Air Act Amendments of 1990 by the Environmental Protection Agency (EPA) in the USA
3. Council Decision 88/540/EEC and 91/690/EEC Annex A, B and C (transitional substances) respectively.

**Vishay Semiconductor GmbH** can certify that our semiconductors are not manufactured with ozone depleting substances and do not contain such substances.

**We reserve the right to make changes to improve technical design  
and may do so without further notice.**

Parameters can vary in different applications. All operating parameters must be validated for each customer application by the customer. Should the buyer use Vishay Semiconductors products for any unintended or unauthorized application, the buyer shall indemnify Vishay Semiconductors against all claims, costs, damages, and expenses, arising out of, directly or indirectly, any claim of personal damage, injury or death associated with such unintended or unauthorized use.

Vishay Semiconductor GmbH, P.O.B. 3535, D-74025 Heilbronn, Germany  
Telephone: 49 (0)7131 67 2831, Fax number: 49 (0)7131 67 2423